

BMCOM

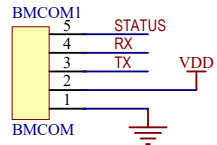

Power Circuit

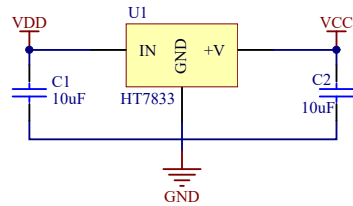

LDO Circuit

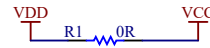

0Ω Circuit

LDO Circuit	0Ω Circuit
LDO:HT7833	NC

Level Shift

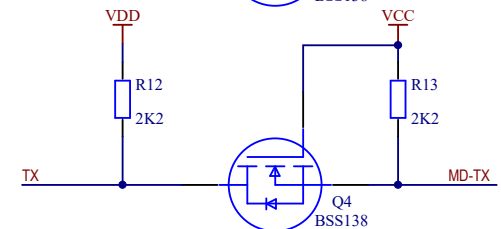
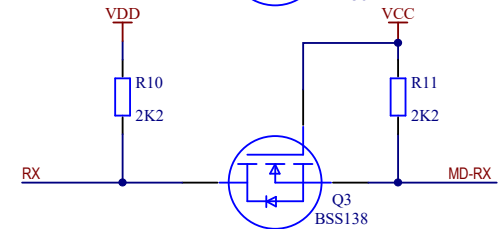
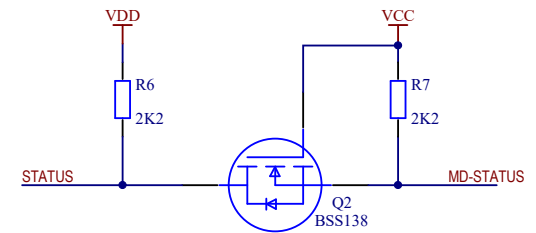

Level Shift Circuit

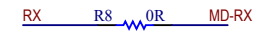

0Ω Circuit

0Ω Circuit	Level Shift Circuit
NC	V

LED Indicator(NC)

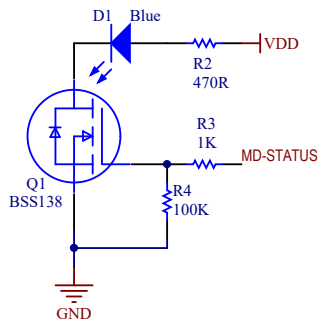

CO2 Detector Digital Module

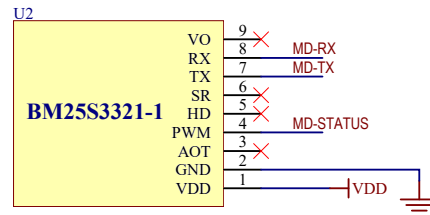

Reserved Interface(NC)

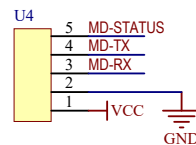
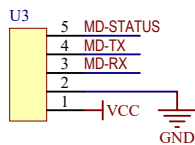

Title: BME58M332
 Design by: BESTMOUDLES TEAM
 Data: 2023/8/15
 Rev: V1.2



Sheet: 1 / 1